

Taking a scientific approach to physics education

Carl Wieman

Stanford University

Department of Physics and Grad School of Education

*copies of
slides to be
available*

*based on the research of many people, some from my science ed research group

I. General Intro--How the brain learns complex thinking.

II. Focusing down--Applying in university classrooms & measuring results. Examples, research data, principles.

III. Focusing tighter- detailed findings from classroom research. What works to improve learning and why. (*things you can use in teaching.*)

Defines teaching expertise.

For teachers- what research says you should do to maximize student learning

For students- the thinking you should do to maximize your learning

“Exercising your brain better.”

Good teacher helps but often is not essential.

My background in education

Students: 17 yrs of success in classes.
Come into my lab clueless about physics?



2-4 years later \Rightarrow expert
physicists!

?????? ~ 30 years ago

Research on how people learn, particularly physics

- explained puzzle
- I realized were more effective ways to teach
- got me started doing science ed research--
experiments & data, basic principles! (~ 100 papers
later)

“Expertise” = thinking like good scientist or engineer

Major advances past 1-2 decades

⇒ New insights on how to learn & teach complex thinking (eng. & sci.)

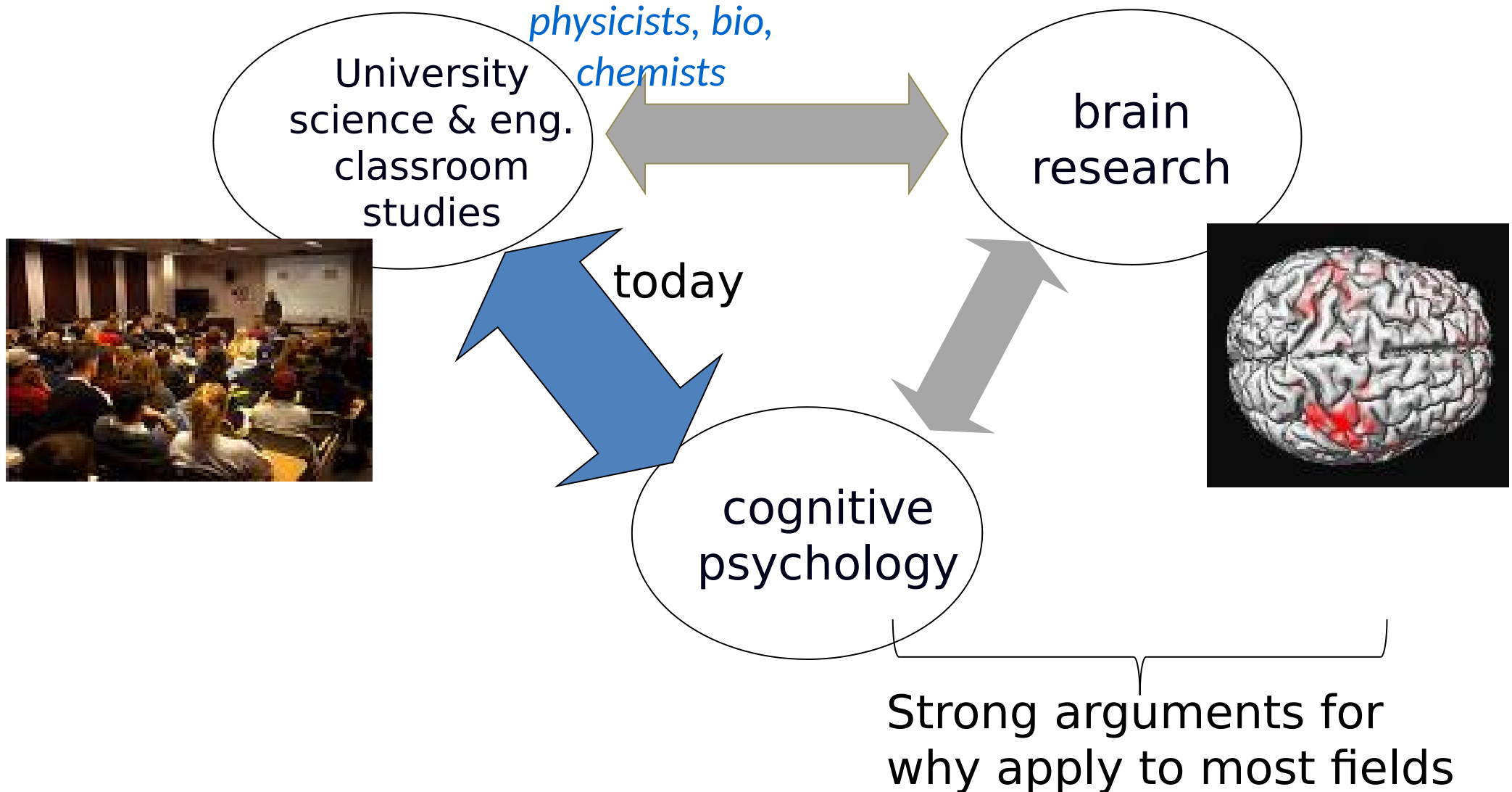

Rethinking how learning happens

old/current model



knowledge



soaks in, varies with brain

focus on:

- selecting best brains
- knowledge soup

new research-based view

brain changeable



transformation



Change neurons by intense thinking.
Improved capabilities.

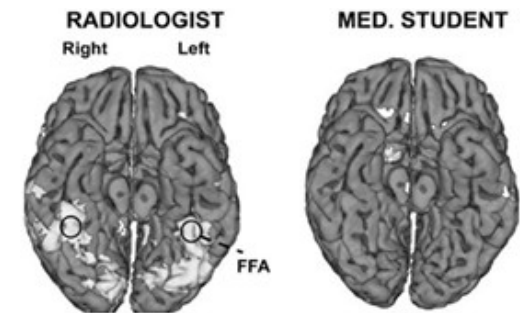

fMRI-- interpreting x-ray image

Brain research– learning is enhancing relevant neuron connections—like muscle development. Intensity & type of exercise critical.

Brain only learns what it practices intently!

Researchers are continually learning more effective ways to teach– brains develop new skills.

“Perfect pitch”– long thought was some extraordinary natural talent. Now we know how to teach it to almost every child.

I. General--How the brain learns scientific & engineering thinking.

II. Focusing down--Applying in university classrooms & measuring results. Examples, research data, principles.

III. Focusing tighter- detailed findings from classroom research.
What works to improve learning and why. (*things you can use*)
Defines teaching expertise.

Basics of most university physics classroom research:

1. Test how well students learn to make decisions like expert (*physicist, biologist, mech. engineer, ...*).

2. Compare results for different teaching methods:

a. Students told what to do in various situations (“lecture”)

b. Practice making decisions in selected scenarios, with feedback. (“active learning”, “research-based”)

Learning in large intro class*

Comparing the learning in class for two ~identical sections. 270 students each. UBC 1st year university physics for engineers.



Control--standard lecture class-- highly experienced Prof with good student ratings.

Experiment-- new physics Ph. D. trained in principles & methods of research-based teaching.

They agreed on:

- Same material to cover (*Cover as much?*)
- Same class time (1 week)
- Same exam (jointly prepared)- start of next class

**Deslauriers, Schelew, Wieman, Sci. Mag. May 13, '11*

Experimental:

1. Short preclass reading assignment--Learn basic facts and terminology without wasting class time.

2. Class starts with question:

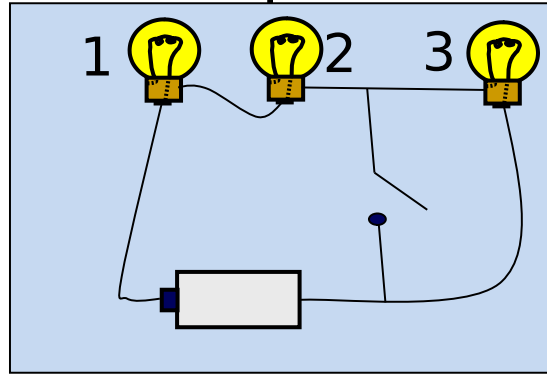

When switch is closed,
bulb 2 will

- stay same brightness,
- get brighter
- get dimmer,
- go out.

3. Individual answer with clicker



Jane Smith
chose a.

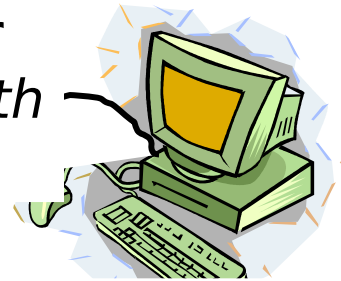

4. Discuss with neighbors, revote. (“Peer instruction”)

Instructor circulating and listening in on conversations! What aspects of student thinking like physicist, what not?

5. Demonstrate/show result

6. Instructor follow up summary– feedback on which models & which reasoning was correct, & **which incorrect and why**. Many student questions.

For more mathematical topics, students write out on worksheets.

Students practicing thinking like physicists--

(choosing, applying, testing conceptual models, critiquing reasoning...)

Feedback—other students, informed instructor, demo

Identical surprise quiz given in both sections

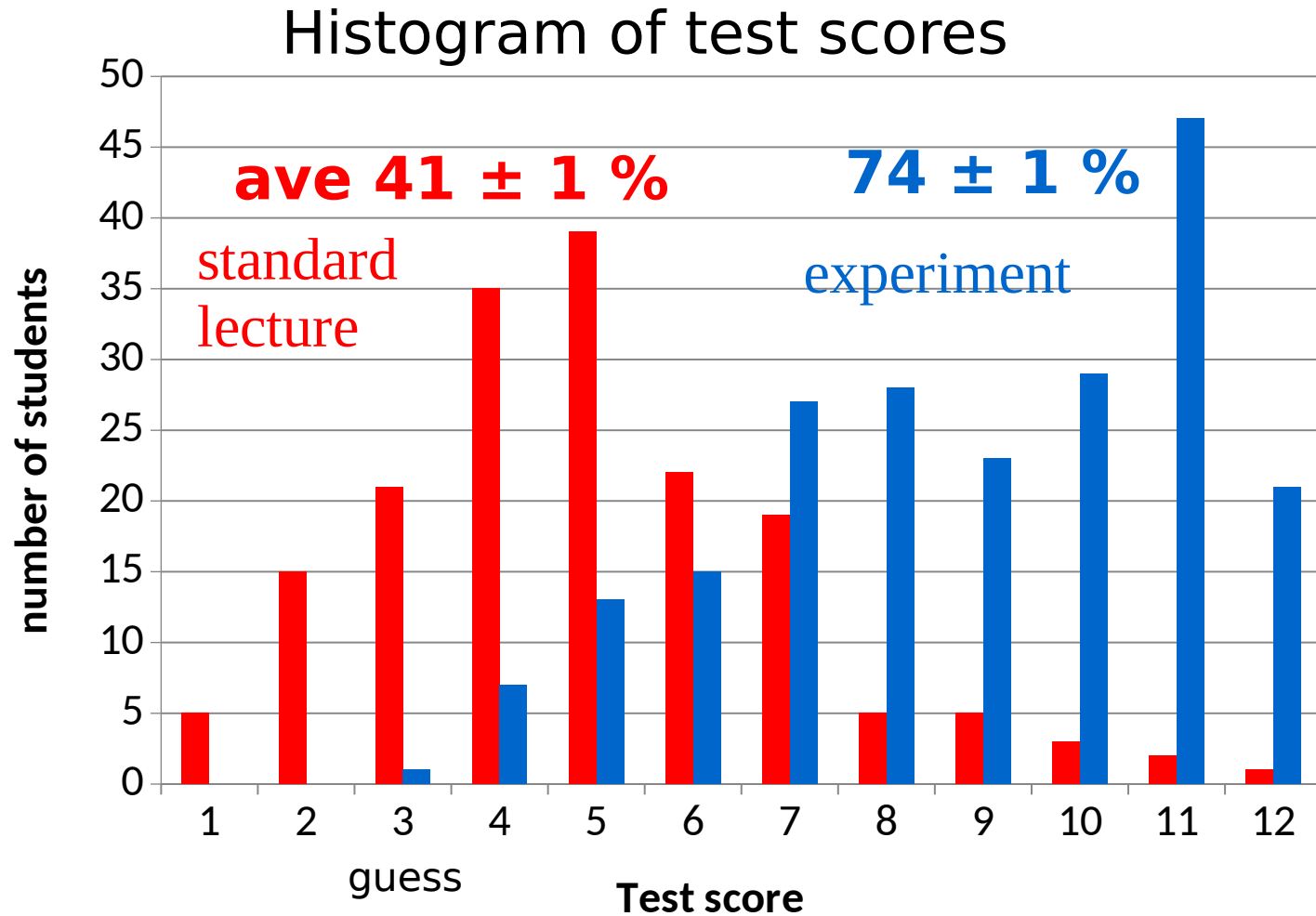

Learning from lecture tiny.
 Clear improvement for entire student population.

Research-based instruction—Advanced Courses



*Design and implementation: Jones, Madison, Wieman, Transforming a fourth-year modern optics course using a deliberate practice framework, Phys Rev ST – Phys Ed Res, V. 11(2), 020108-1-16 (2015). **1 standard deviation improvement***

[Worksheets](#)

Transformed teaching of Stanford physics majors

8 physics courses 2nd-4th year

Also works well for graduate courses

(P. Lepage Quant. Field Theo. Am J. Phys. 2021)

Structure of active learning class

Good for any subject, level, class size

Actions

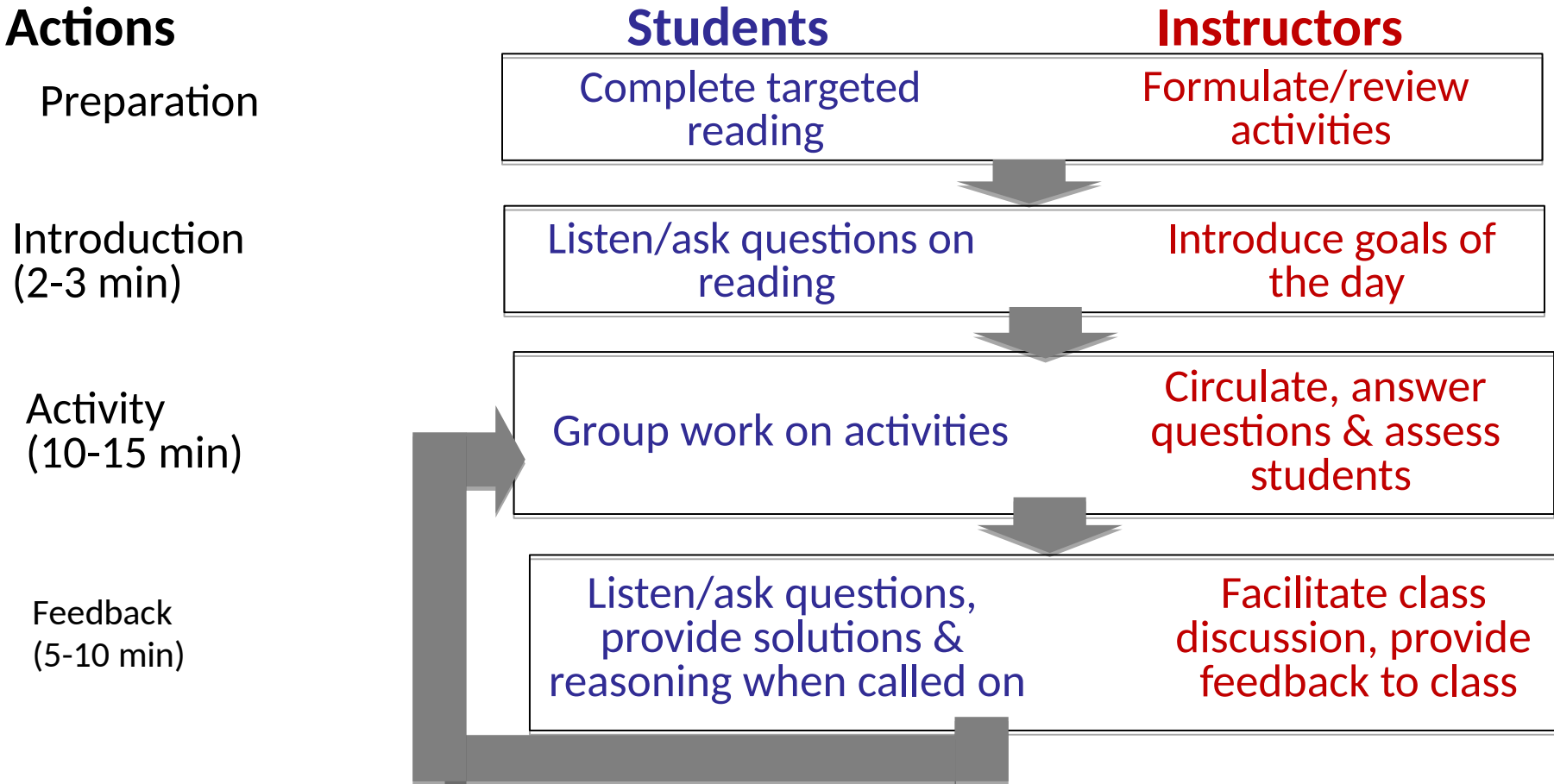

Two essential features:

- **students are thinking—practicing expert reasoning**
- **instructor more knowledgeable about that thinking—more effective teaching & feedback (*and they enjoy teaching more*)**

Evidence from the University Classroom

~ 1000 research studies from undergrad science and engineering comparing traditional lecture with “active learning” (or “research-based teaching”).

- consistently show greater learning
- lower failure & dropout rates

*Meta-analysis
all sciences & eng. similar.
PNAS Freeman, et. al. 2014*

But how to compress distribution?

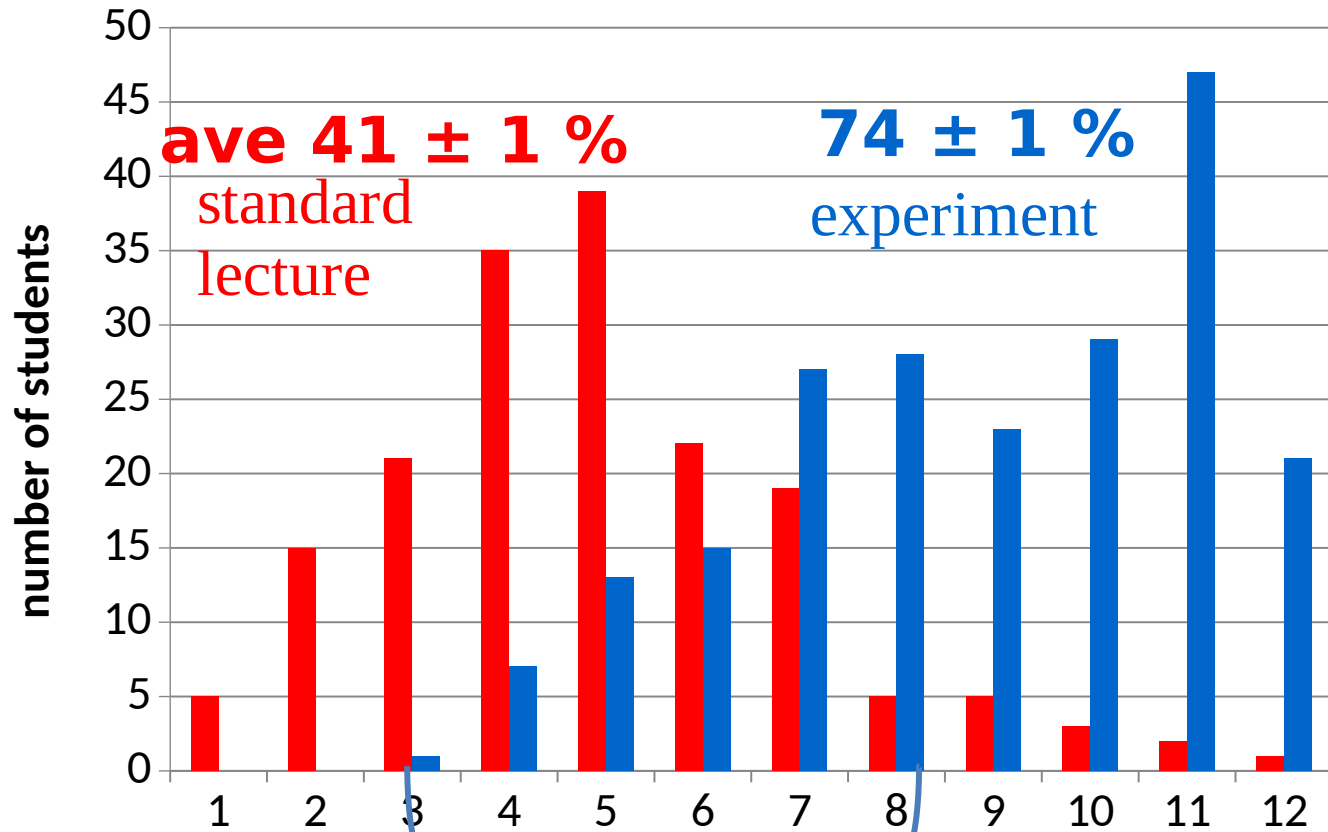

Good teaching methods not enough?

Other factors?

Got data on many things.
Lots of statistics
(*multivariable regression*)

What matters?
math taken?– no
demographics?

Move all to top?
Stanford students.

Origin of performance gaps by demographic groups

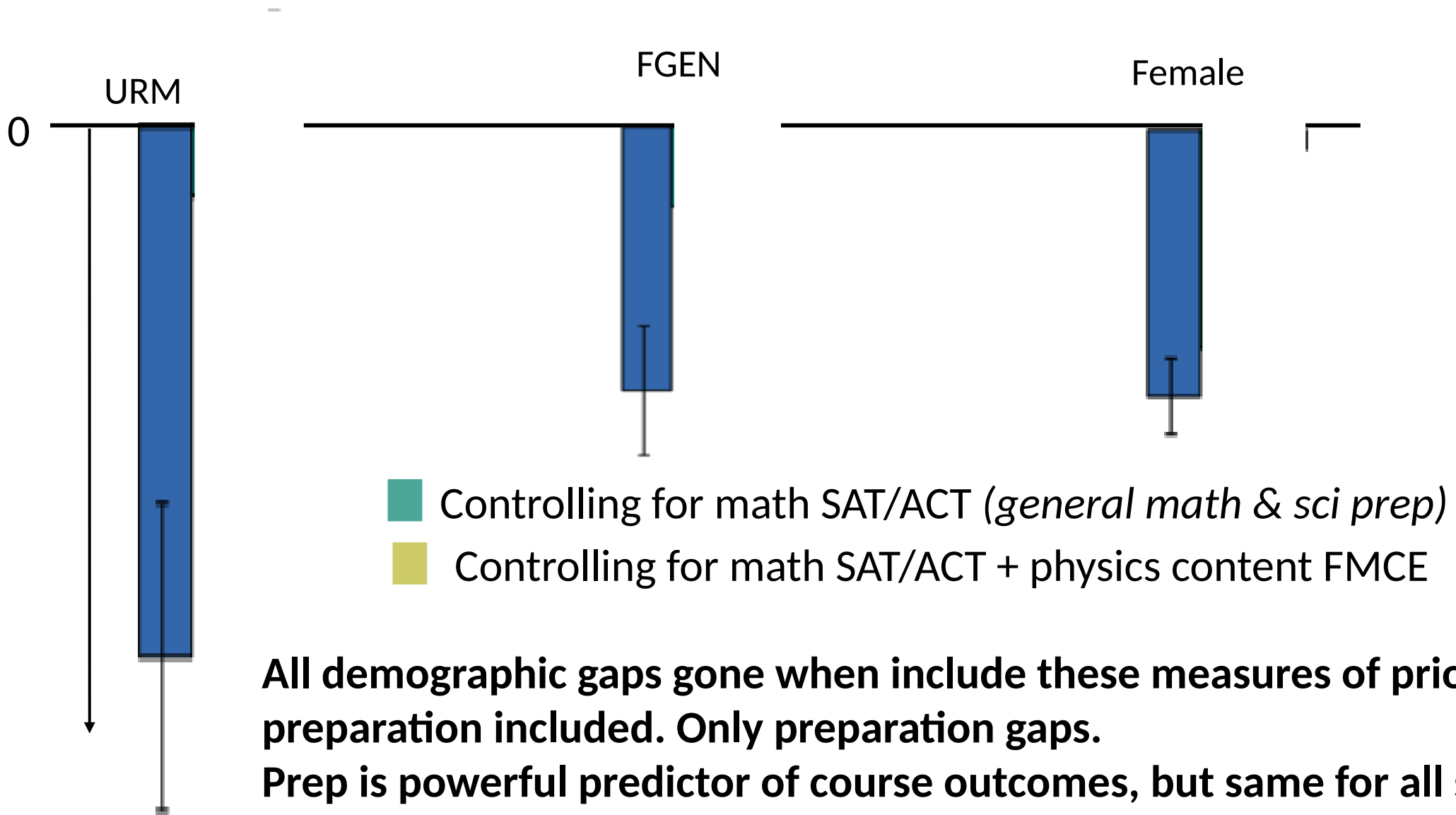

Why does this dependence of grades on prior preparation matter?

Doing poorly in physics 1 is barrier to physics & engineering major.

“Failure analysis”—how does probability of failing depend on preparation?

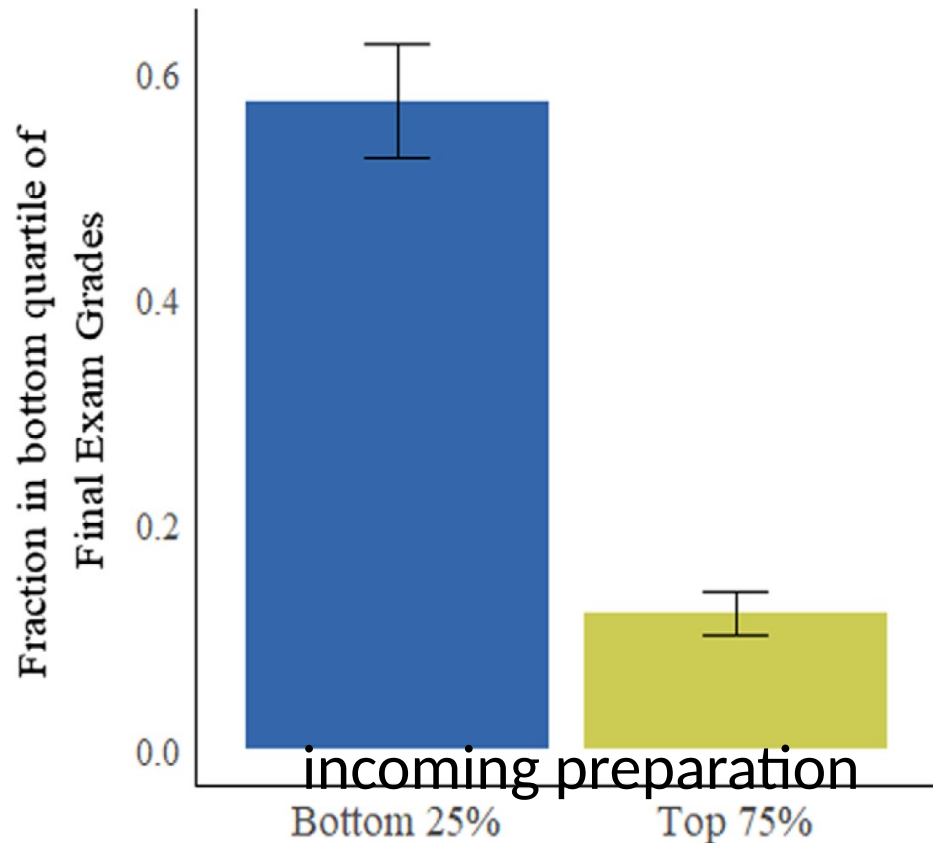

Math SAT & FMCE test crude measures of prior preparation!

Created our own diagnostic test. 30 minutes, explains $\sim 1/2$ variance, most of failure risk.

Stanford and Colorado (and Cornell) **very similar dependence on preparation factors!**

⇒ nature of the teaching, not the students.

Optimize coverage and pace for top half of the preparation.
Confuse educational privilege with talent.

I. General--How the brain learns scientific & engineering thinking.

II. Focusing down--Applying in university classrooms & measuring results. Examples, research data, principles.

**III. Focusing tighter- detailed findings from classroom research. What works to improve learning and why.
(things you can use in teaching.)
Defines teaching expertise.**

III. Principles and Practices. Things you can use.

Teaching to think like physicist; what the research says is important.

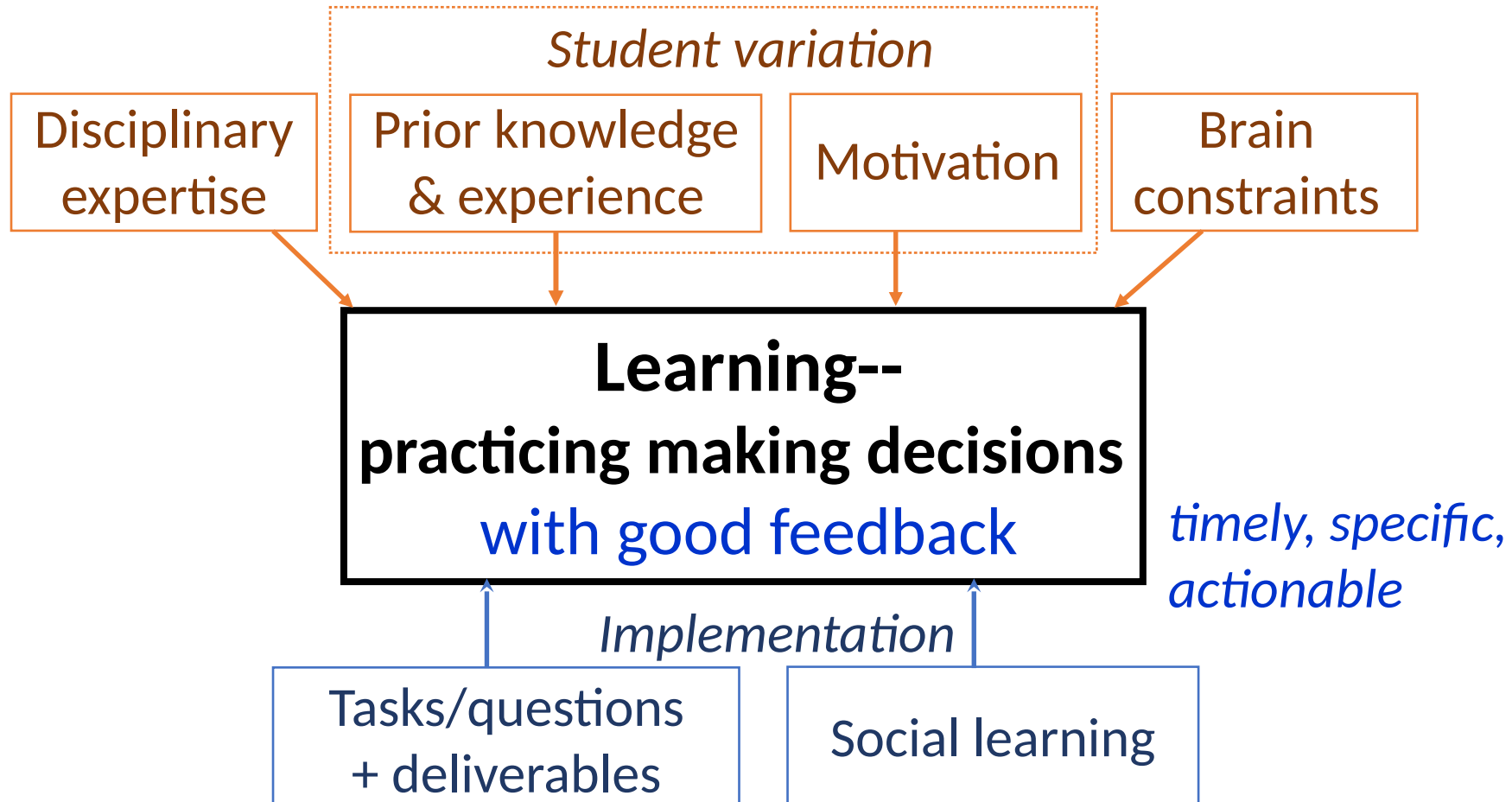

Defines teaching expertise.

Practices that research shows produce more learning
(*basis for better evaluations of teaching*)

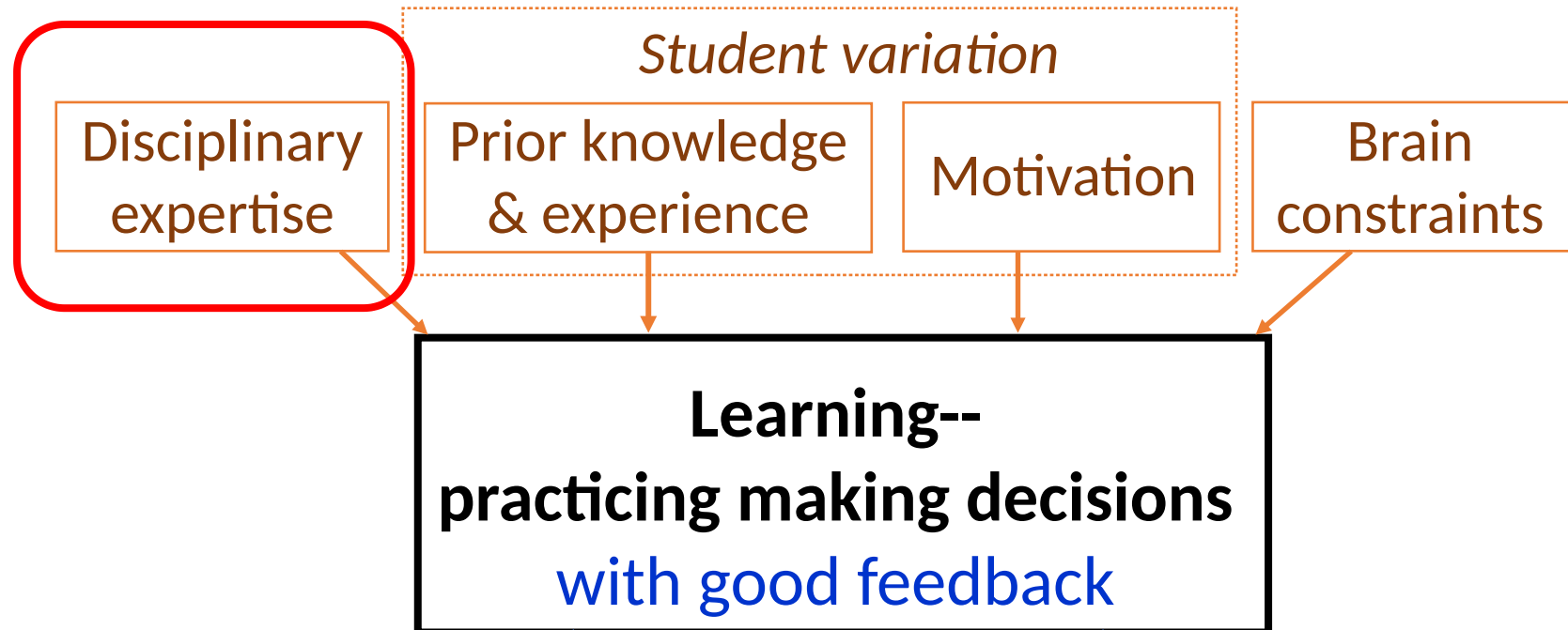

How enter into design of practice activities (in class, then homework...)?

Wieman Group Research

How experts in science, engineering, and medicine solve authentic problems.

Process defined by making set of decisions with limited information.

Same set of 29 decisions, all science & engineering!

- Decide: what concepts/models relevant
- Decide: What information relevant, irrelevant, needed.
- Decide: what approximations are appropriate.
- Decide: potential solution method(s) to pursue.
-
- Decide: does solution/conclusion make sense, how to test?

but, **making** the decisions requires specialized disciplinary knowledge. Organized to optimize.

- Decide: what concepts/models relevant
- Decide: What information relevant, irrelevant, needed.
- Decide: what approximations are appropriate.
- “ ” : potential solution method(s) to pursue.
-
- does solution/conclusion make sense, how to test?

**Learning good “physicist” thinking*--
requires practicing making problem-solving
decisions
in authentic problem context, using physics
knowledge.**



*Nearly all these decisions removed from typical course problems!
Students learn information, not how to use!*

* “Deliberate Practice”, A. Ericsson research. See “Peak;...” by Ericsson for readable summary

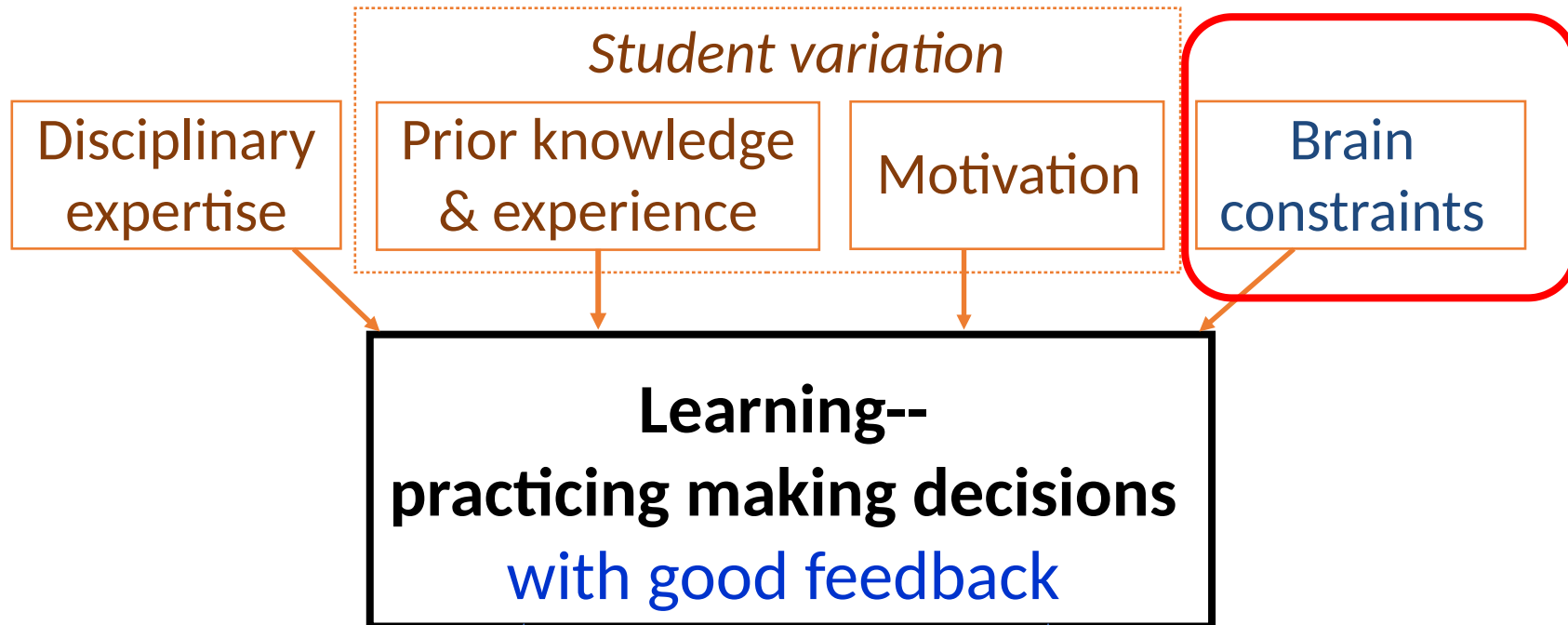

How enter into design of practice activities (in class, then homework...)?

Brain Constraints

Memory (simplified)

1. “Short-term working memory” (buffer)

- tiny capacity (5-7 items)
- time scale of minutes
(*what can pay attention to*)

*When hear or see new items,
pushes out old. Not processed
and into LTM*

2. Long term memory

- Large capacity
- Long duration

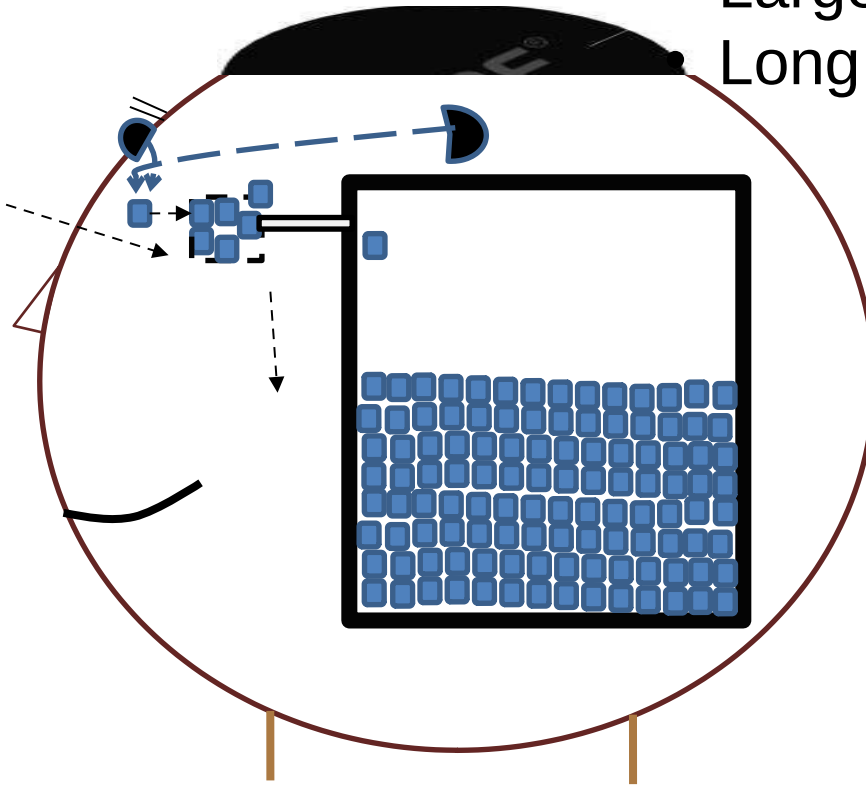

Designing thinking practice activities

Brain constraints:

1) working memory has limit 5-7 new items.

Additional items reduce processing & learning.

- Split attention (checking email, ...)—learning disaster **(worse online!)**
- Jargon, nice picture, interesting little digression or joke actually hurts learning.

2) long term memory– biggest problem is recall after learning additional stuff--interference.

Not just learn once and done. Interference suppressed by repeated interleaved recall.

*So not just cover chapter 1 and done. Reconnect during chap 3, 4...
For students-- do on your own.*

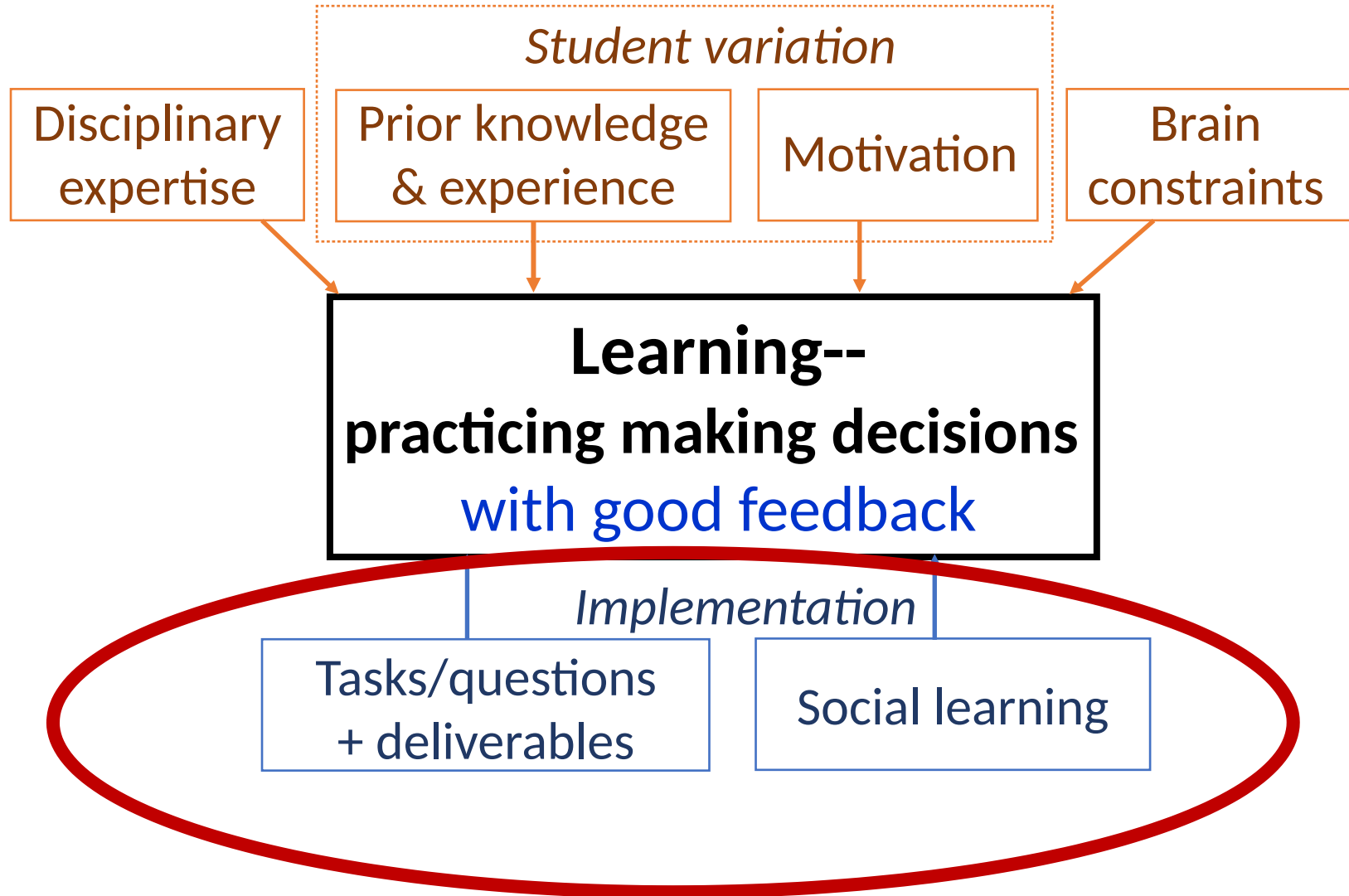

Implementation—

1. Design good tasks (as above) but with clear **deliverables. Things student has to complete.**

(define task & instructor use to guide feedback)

2. **Social learning** (working in groups, in class 3-4)

Talking to fellow students better than hearing expert instructor explain??

- Yes! People teaching/explaining to others triggers unique cognitive process \Rightarrow learning
- **Very useful as a teacher** to listen in on student conversations!

For students– new material. “How would I explain this to a 14-year-old sibling?”

Conclusion—

Research shows what is good teaching design and implementation.

Better learning than traditional lecture & why.

“But traditional lectures can’t be as bad as you claim. Look at all us university professors who were taught by traditional lectures.”

Bloodletting was the medical treatment of choice for ~ 2000 years, based on exactly the same logic.

Need proper comparison group. (science)

Conclusion--Research shows good design and implementation.
Better learning than traditional lecture & why.

Brain learns what it practices. Develops new capabilities.

Good References:

- S. Ambrose et. al. *“How Learning works”*
- D. Schwartz et. al. *“The ABCs of how we learn”*
- Ericsson & Pool, *“Peak:...”*
- Wieman, *“Improving How Universities Teach Science”*
- **cwsei.ubc.ca-- resources** (implementing best teaching methods), references, effective clicker use booklet and videos
- A Detailed Characterization of the Expert Problem-Solving Process in Science and Engineering: Guidance for Teaching and Assessment, A. Price et al, [://doi.org/10.1187/cbe.20-12-0276](https://doi.org/10.1187/cbe.20-12-0276)

slides will be available

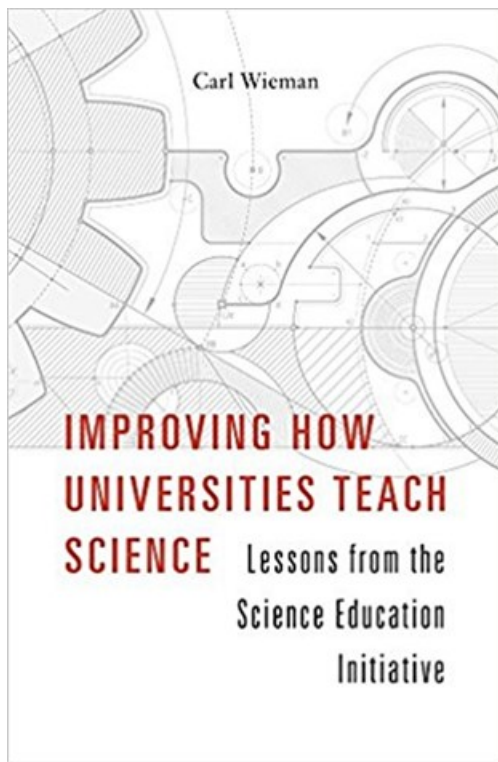

For administrators:

What universities and departments can do. Experiment on large scale change of teaching.

Changed teaching of ~250 science instructors & 200,000 credit hrs/yr UBC & U. Colorado

Important results:

1. Large scale change is possible. (Entire departments)
2. When faculty learn how to teach this way (~50 hrs) they prefer to lecturing. Costs the same.
3. Need to recognize, support, and incentivize teaching expertise.
4. Need better way to evaluate teaching-

Linear regression results very similar across institutions*

- Only math SAT/ACT & FMCE-pre predict performance
- Stanford & Col have same coefficients (0.3), explain 1/3 of variation
- Demographic gaps similar and only come from prior preparation

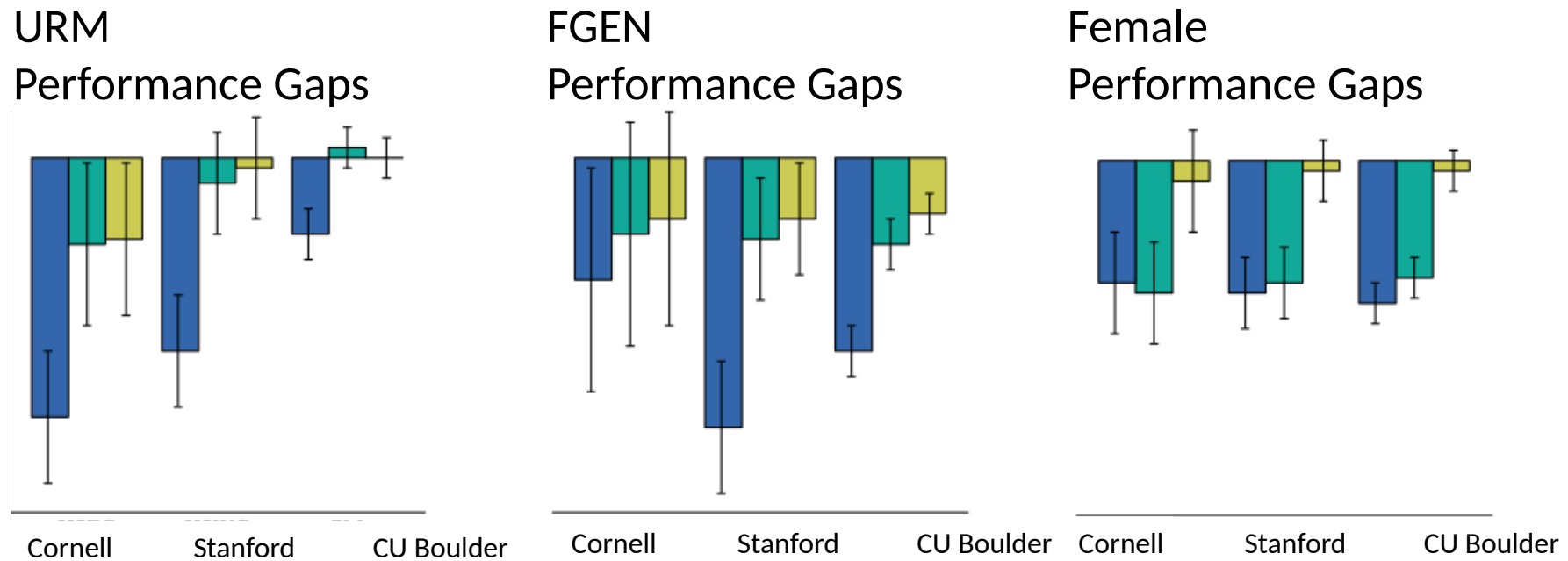

- Controlling for math SAT/ACT (*general math & sci prep*)
- Controlling for math SAT/ACT + physics content FMCE

Teaching to think (*make decisions*)
like expert, what research says is
important

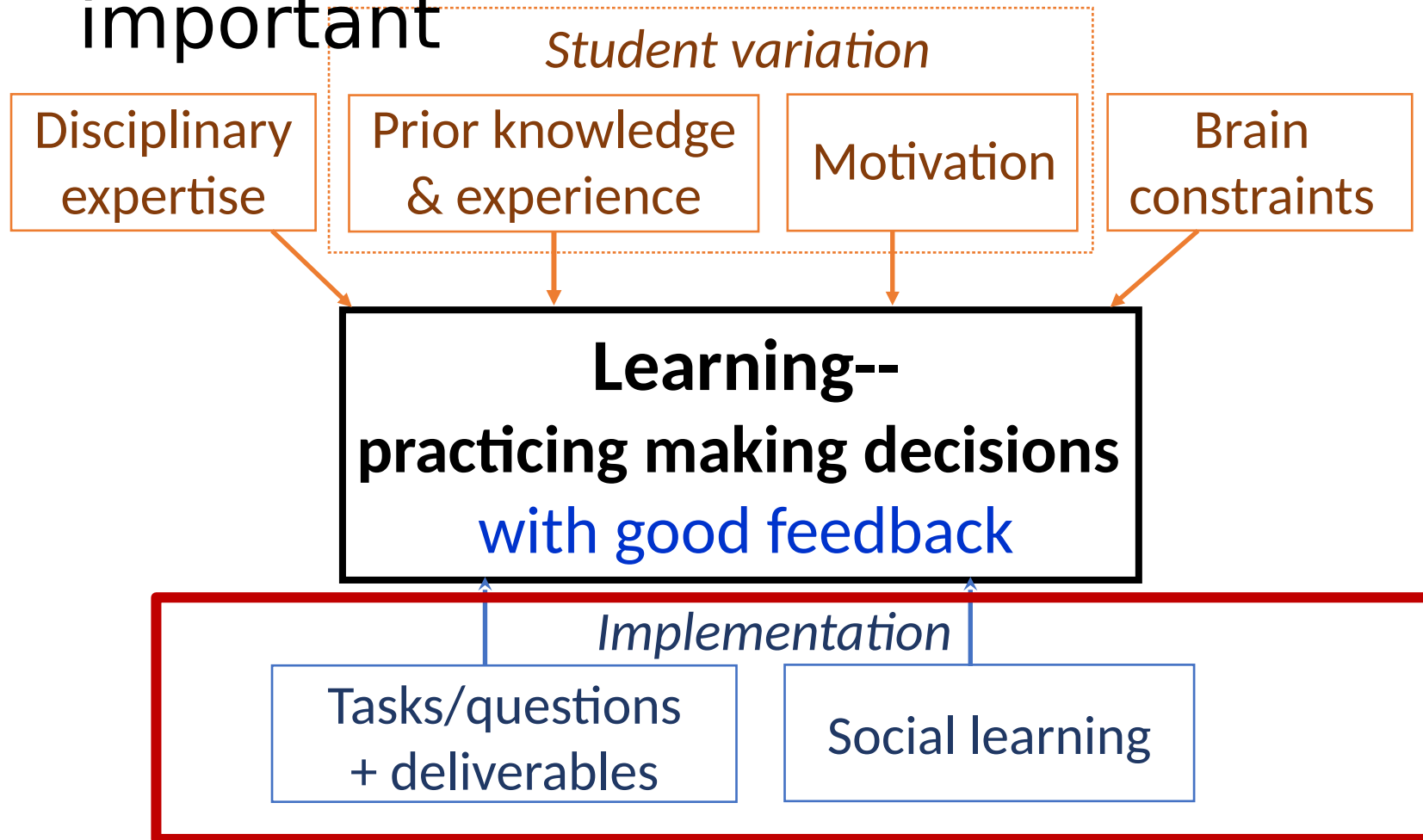

Conclusion:

Research has established teaching expertise at university level. Practices that are more effective.

When learned and applied:

- students learn more
- students and teaching staff prefer

Potential to dramatically improve post secondary education.

How to make it the norm at universities?

~ 20 extras below, not in talk

Final Exam Scores

nearly identical problems

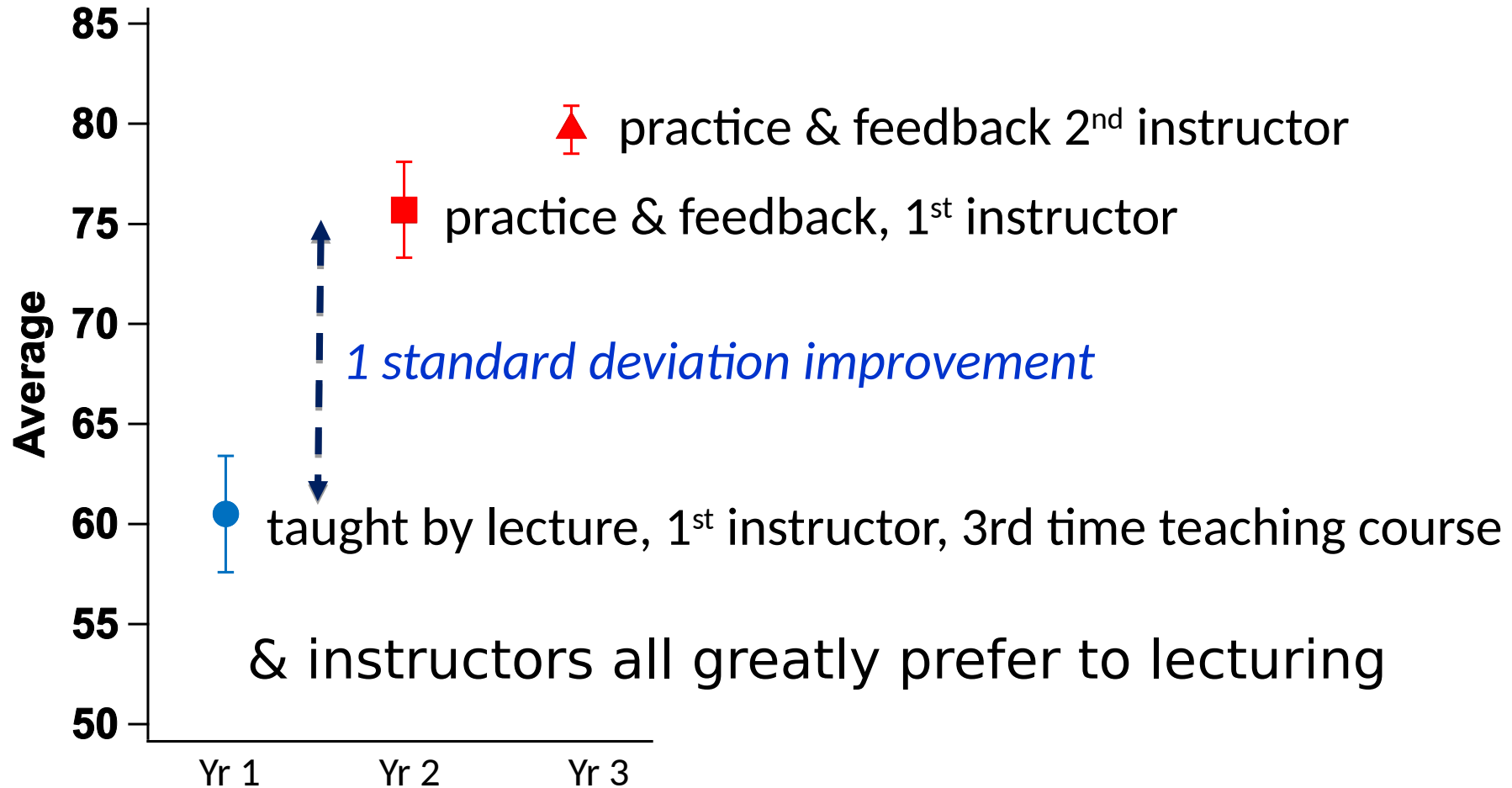

Jones, Madison, Wieman, Transforming a fourth year modern optics course using a deliberate practice framework, Phys Rev ST - Phys Ed Res, V. 11(2), 020108-1-16 (2015)

Necessary 1st step-- better evaluation of teaching

“A better way to evaluate undergraduate science teaching”

Change Magazine, Jan-Feb. 2015, Carl Wieman

Requirements:

- 1) measures what leads to most learning
 - 2) equally valid/fair for use in all courses
 - 3) actionable-- how to improve, & measures when do
 - 4) is practical to use routinely
- student course evaluations do only #4

Better way--characterize the practices used in teaching a course, extent of use of research-based methods. 5-10 min/course

“Teaching Practices Inventory”

<http://www.cwsei.ubc.ca/resources/TeachingPracticesInventory.htm>

Similar comparison of teaching methods. Computer science & looking at fail/drop rates over term. U. Cal. San Diego,

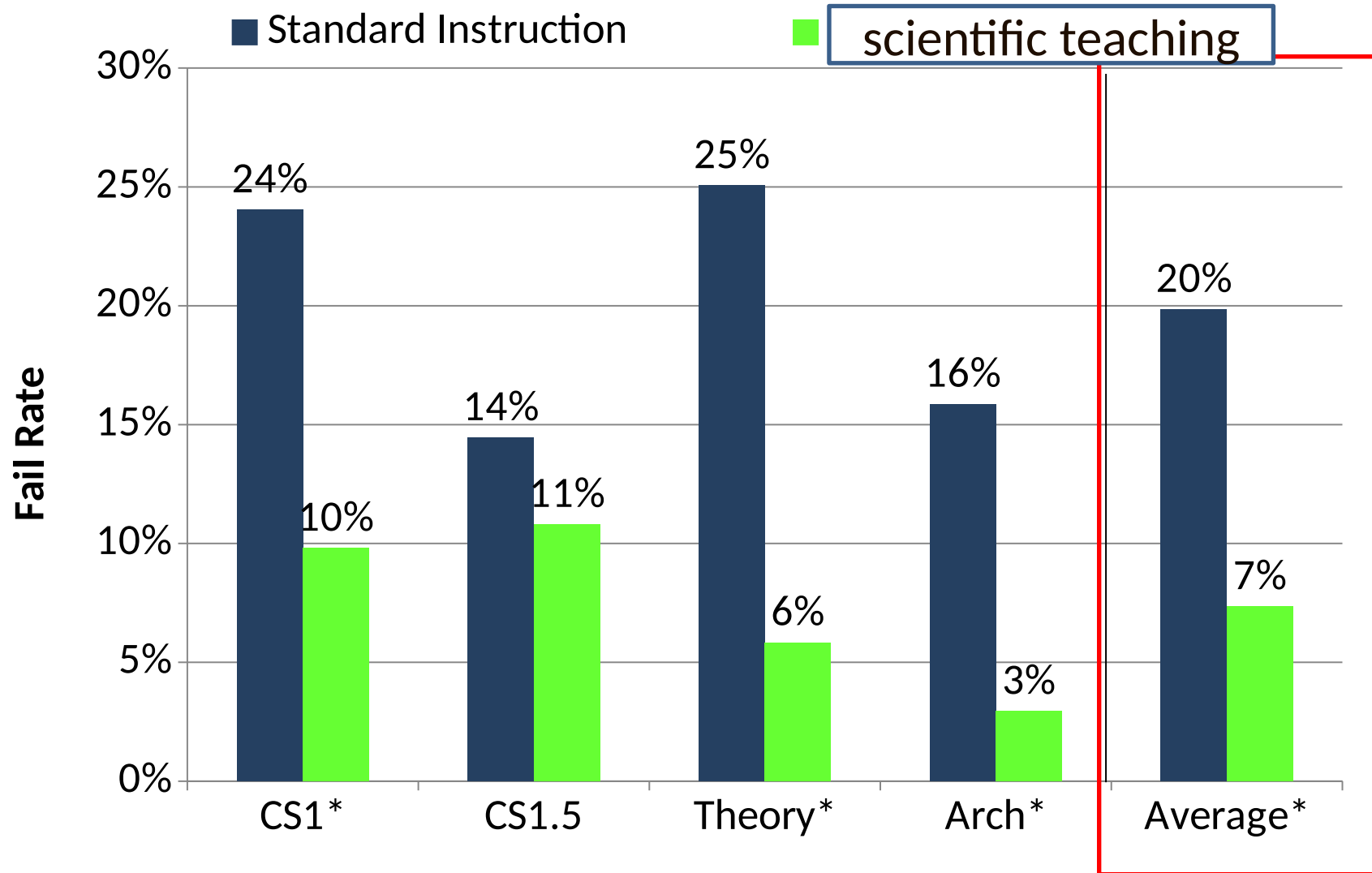

same 4 instructors, better methods = 1/3 fail rate

Categories of the 29 Science & Engin. Problem Solving Decisions

(Somewhat time ordered but involve extensive iteration)

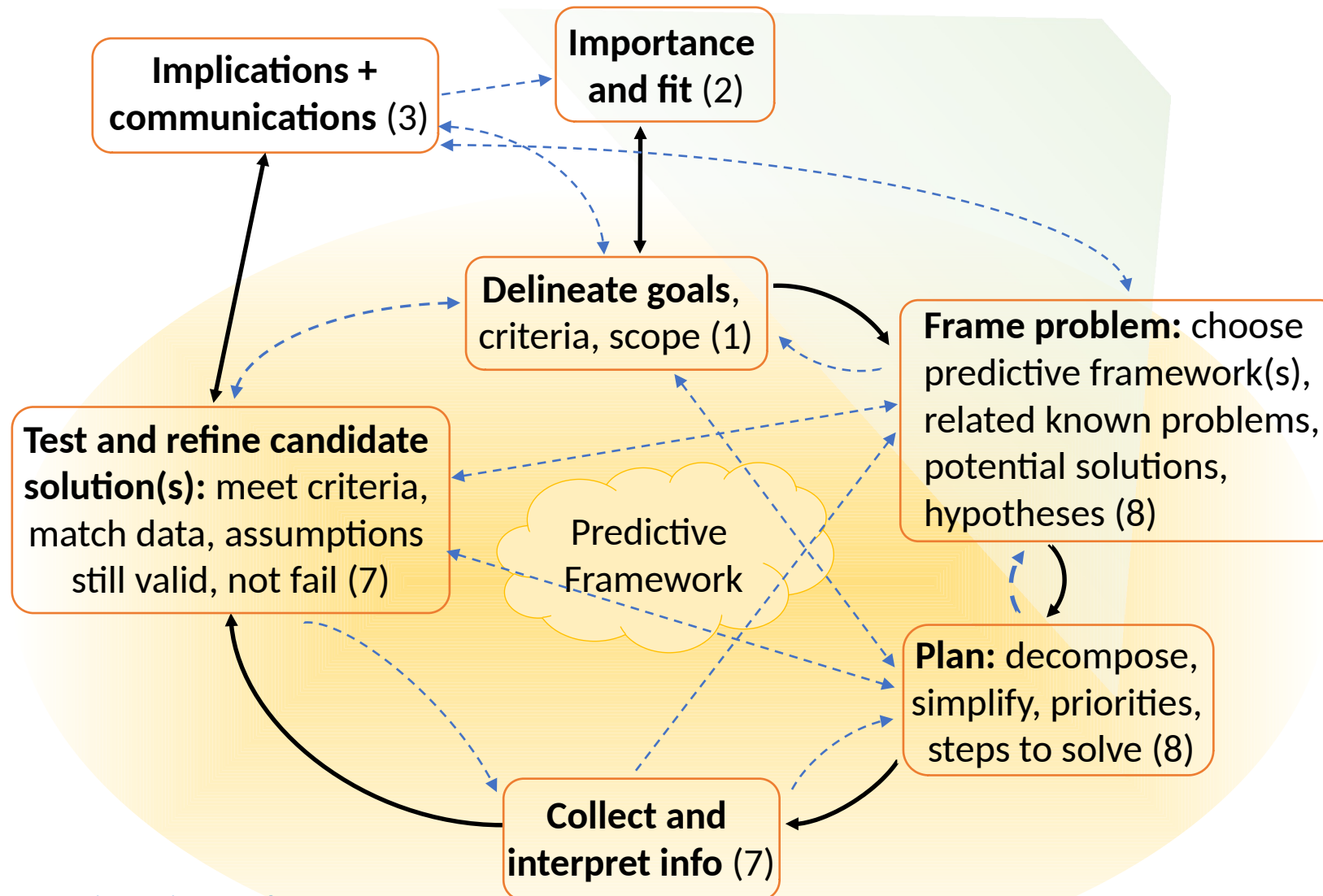

Blue arrows are iteration paths.
Depend on reflection .

Improving measure of prior preparation

FMCE & math SAT crude measures.

Created our own diagnostic. 20-30 minutes to complete.

Use to advise students on sequence (honors, physics 1, alg. based)

Phys 41 Exam	Model 1	Model 2
Grade		
SAT Score		0.25*** (0.060)
Diagnostic Score	0.61*** (0.05)	0.40*** (0.068)
FMCE Pre-Score		0.18** (0.059)
R-squared	0.39	0.46

25 minute test. Predict 0.4 of variance of grade, who will fail.

4. Surprisingly strong dependence. Course starts from 0.
Is Stanford special?



Did similar analysis for Cornell and Univ. of Colorado

	Stanford	Colorado
# students/yr	~ 500	~ 2000
selectivity	<1%	~ 50%
% in top 10% of HS class	96%	29%
Ave percentile math SAT/ACT	97	89
Average prescore on FMCE (%)	55%	43%
Normalized pre-post gain on FMCE	46	52

Cornell & Stanford similar

Colorado very different student population

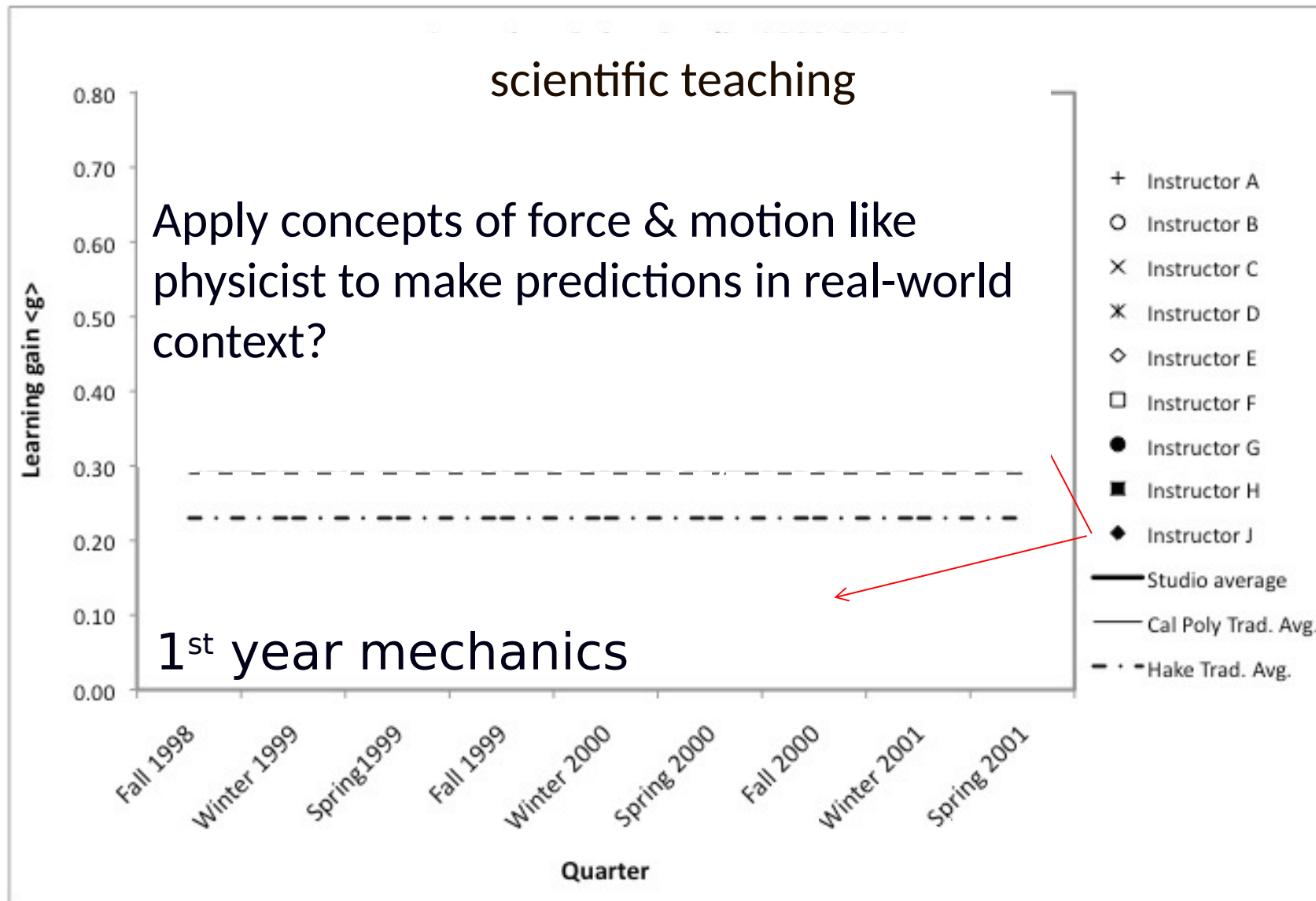

9 instructors, 8 terms, 40 students/section.
 Same instructors, better methods = more learning!

Transforming teaching of Stanford physics majors

8 physics courses 2nd-4th year, seven faculty, '15-'17

- Attendance up from 50-60% to ~95% for all.
- Student anonymous evaluation overwhelmingly positive (4% negative, 90% positive): **(most VERY positive, “All physics courses should be taught this way!”)**
- All the faculty greatly preferred to lecturing.

Typical response across ~ 250 faculty at UBC & U. Col. Teaching much more rewarding.

Applications of research instructors can use immediately (*some very common but bad practices*)

1. Organization of how a topic is presented
2. Feedback to students
4. Review lectures (*why often worse than useless*)

(see cwsei research papers & instructor guidance)

1. Organization of how topic is presented.

Very standard teaching approach:

Give formalism, definitions, equa's, and then move on to apply to solve problems.

What could possibly be wrong with this?

*Nothing, **if** learner has an expert brain.*

Expert organizes this knowledge as tools to use, along with criteria for when & how to use.

- Student does not have this system for organizing knowledge. Can only learn as disconnected facts, not linked to problem solving. Not recall when need.
- Much higher demands on working memory = less capacity for processing.
- Unmotivating— see no value.

A better way to present material—

“Here is a meaningful problem we want to solve.”

*“Try to solve” (and in process notice key features of context & concepts—
basic organizational structure).*

Now that they are prepared to learn--*“Here are tools (formalism and
procedures) to help you solve.”*

*More motivating, better mental organization & links, less cognitive
demand = more learning.*

*“A time for telling” Schwartz & Bransford (UW), *Cog. and Inst.* (1998),
Telling after preparation ⇒ x10 learning of telling before,
and better transfer to new problems.*

3. Feedback to students

Standard feedback—“You did this problem wrong, here is correct solution.”

Why bad? Research on feedback—simple right-wrong with correct answer very limited benefit.

Learning happens when feedback:

- timely and specific on what thinking was incorrect and why
- how to improve
- learner acts on feedback.

Building good feedback into instruction among most impactful things you can do!

1. Designing homework & exam problems (& how to improve)

What expertise being practiced and assessed?

- Provide all information needed, and only that information, to solve the problem
- Say what to neglect
- *Possible* to solve quickly and easily by plugging into equation/procedure from that week
- Only call for use of one representation
- Not ask why answer reasonable, or justify decisions

Components of expert thinking:

- ~~• recognizing relevant & irrelevant information~~
- ~~• select and justify simplifying assumptions~~
- ~~• concepts and models + **selection criteria**~~
- ~~• moving between specialized representations
(graphs, equations, physical motions, etc.)~~
- ~~• Testing & justifying if answer/conclusion reasonable~~

How to improve? Don't do the bad stuff.

Enhancing Diversity in Undergraduate Science: Self-Efficacy Drives Performance Gains with Active Learning, CBE-LSE. 16

Cissy Ballen, C. Wieman, Shima Salehi, J. Searle, and K. Zamudio

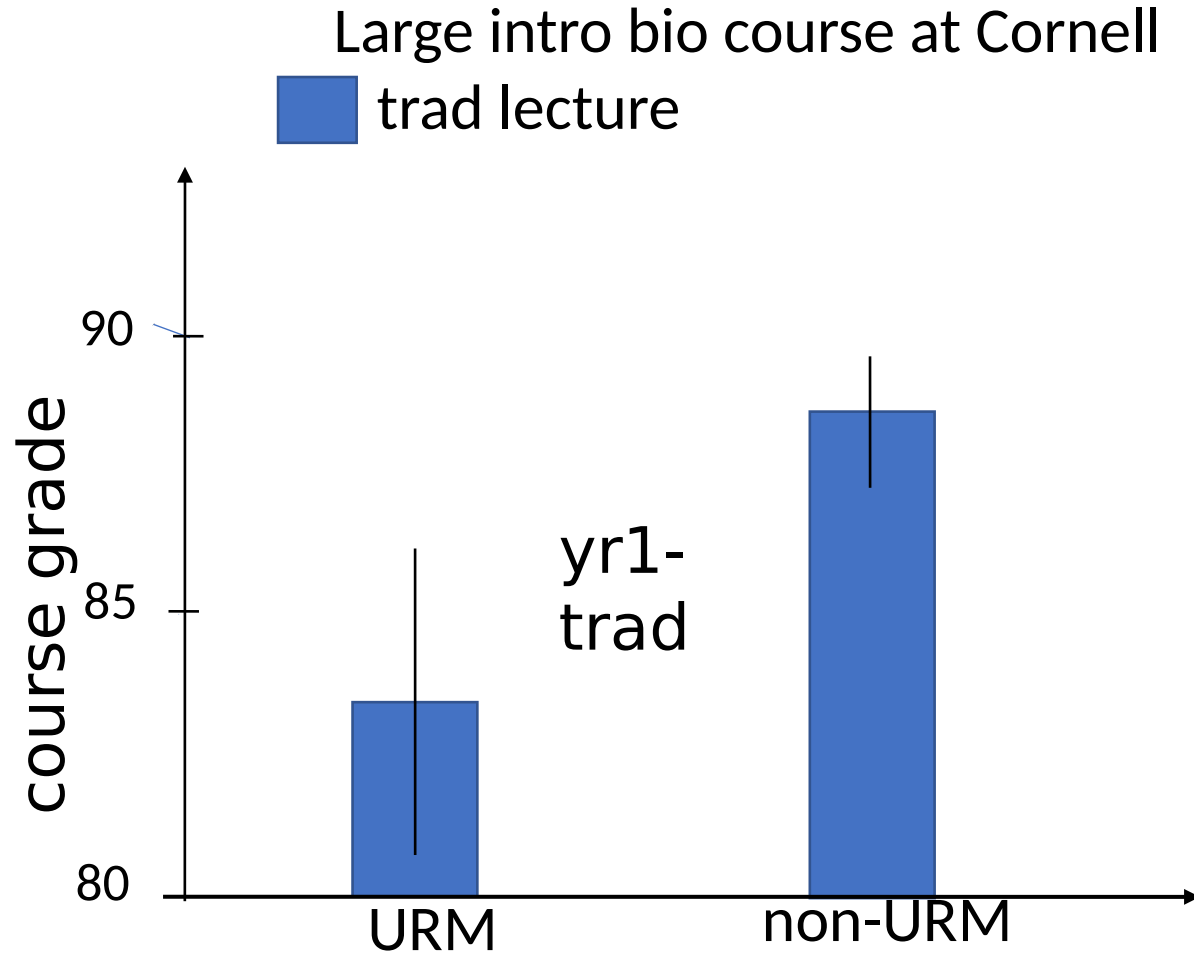

(small correction for incoming prep)

Enhancing Diversity in Undergraduate Science: Self-Efficacy Drives Performance Gains with Active Learning, CBE-LSE. 16

Cissy Ballen, C. Wieman, Shima Salehi, J. Searle, and K. Zamudio

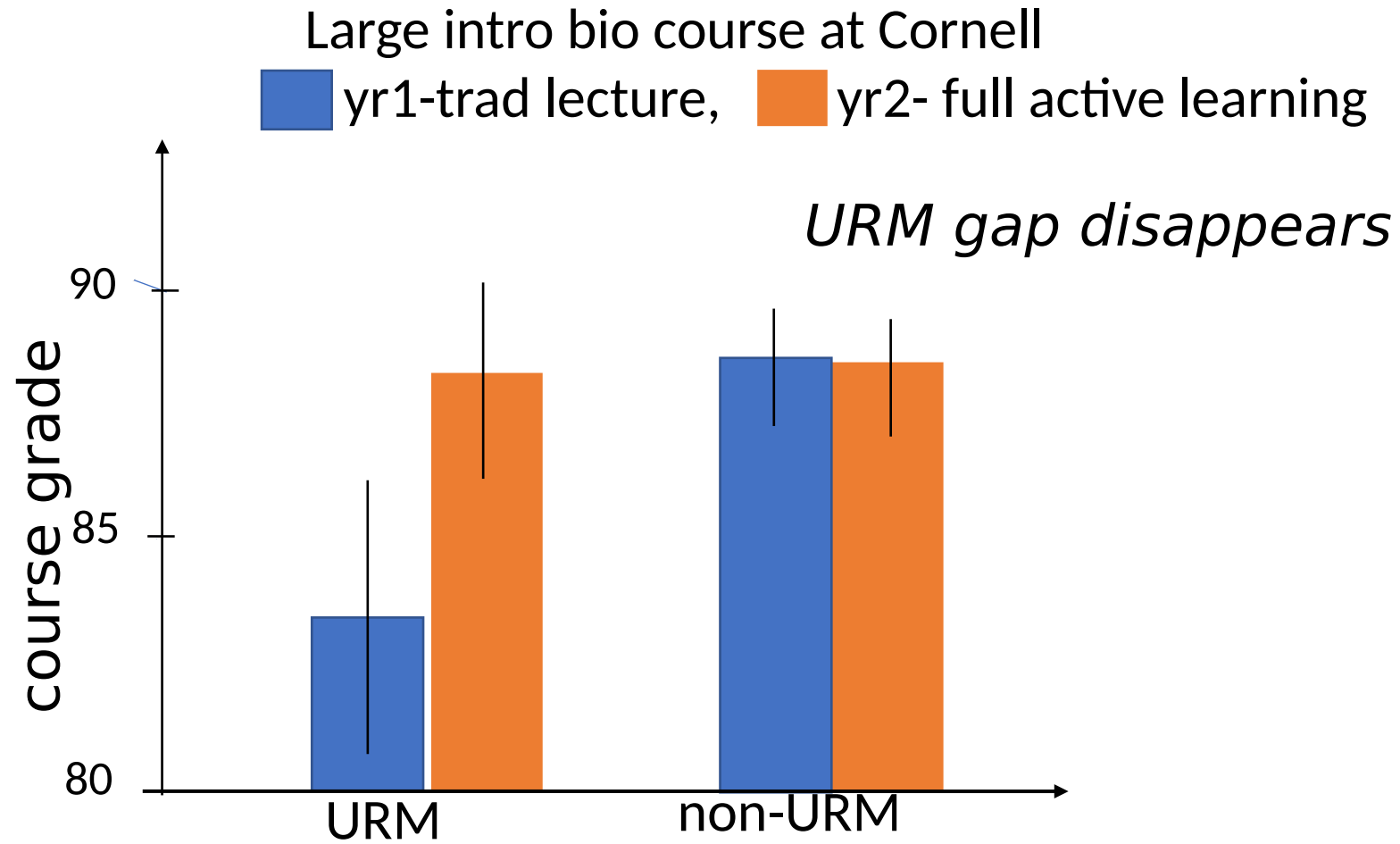

Applications of research instructors can use immediately (*some very common but bad practices*)

1. Organization of how a topic is presented
2. Design of homework and exam problems
3. Review lectures (*why often worse than useless*)

(see cwsei research papers & instructor guidance)

How it is possible to cover as much material?

(if worrying about covering material not developing students expert thinking skills, focusing on wrong thing, but...)

- transfers information gathering outside of class,
- avoids wasting time covering material that students already know

Advanced courses-- often cover more

Intro courses, can cover the same amount.

But typically cut back by ~20%, as faculty understand better what is reasonable to learn.

Most university instructors and administrators don't know about, but growing recognition of research:

- US National Acad. of Sciences (2012)
- PCAST Report to President (2012)

Calling on universities to adopt

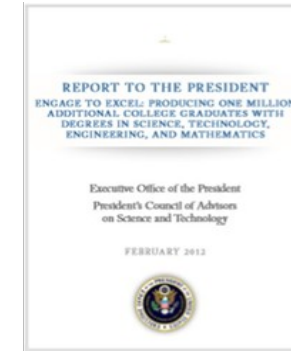
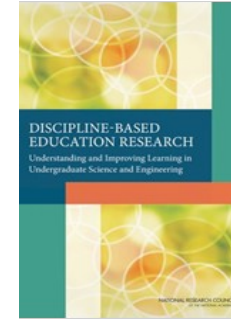

Amer. Assoc. of Universities (60 top N. Amer. Univ.'s—Stanford, Harvard, Yale, MIT, U. Cal, ...)

Pre 2011-- *“Teaching? We do that?”*

2017 Statement by President of AAU--

“We cannot condone poor teaching of introductory STEM courses ... simply because a professor, department and/or institution fails to recognize and accept that there are, in fact, more effective ways to teach. Failing to implement evidence-based teaching practices in the classroom must be viewed as irresponsible, an abrogation of fulfilling our collective mission”

“ A time for telling” Schwartz and Bransford,
Cognition and Instruction (1998)

People learn from telling, but only if well-prepared to learn.

Activities that develop knowledge organization structure.

Students analyzed contrasting cases \Rightarrow recognize key features

Predicting results of novel experiment

<i>Condition</i>	<i>Noted in Study Work</i>	<i>Missed in Study Work</i>
Analyze + lecture	.60	.26
Analyze + analyze	.18	.15
Summarize + lecture	.23	.06

Pre-class Reading

Purpose: Prepare students for in-class activities; move learning of less complex material out of classroom

Spend class time on more challenging material, with Prof giving guidance & feedback

Can get >80% of students to do pre-reading if:

- Online or quick in-class quizzes for marks (tangible reward)
- Must be targeted and specific: students have limited time
- DO NOT repeat material in class!

Heiner et al, Am. J. Phys. 82, 989 (2014)

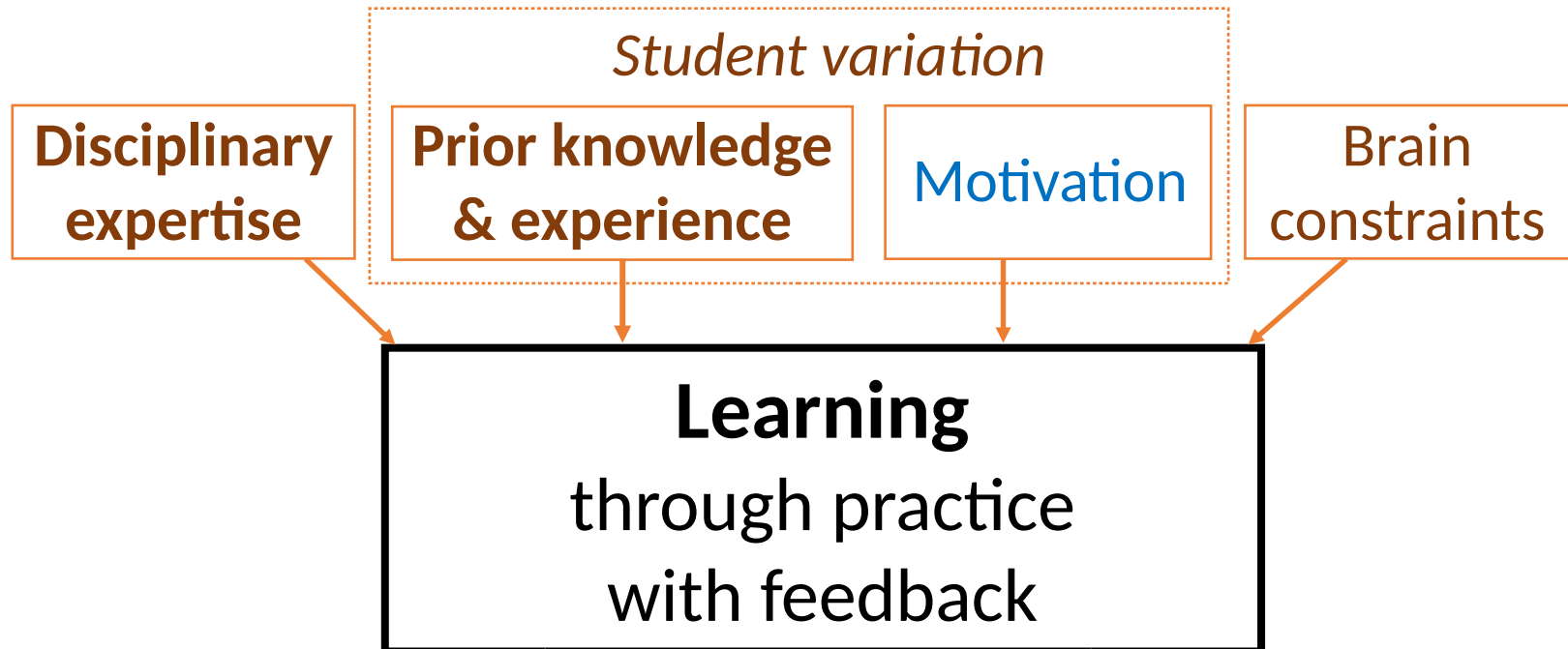

How enter into design of practice activities (in class, then homework...)?

Motivation-- essential
(complex- depends on background)

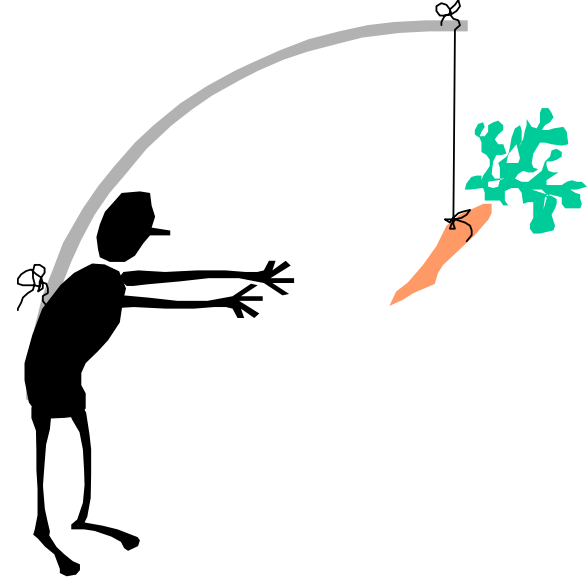

Enhancing motivation to learn

- a. Relevant/useful/interesting to learner
(meaningful context-- connect to what they know and value)
requires expertise in subject
- b. Sense that **can** master subject and how to master, recognize they are improving/accomplishing
- c. Sense of personal control/choice

A few final thoughts—

1. Lots of data for college level, does it apply to K-12?

There is some data and it matches.

Harder to get good data, but cognitive psych says principles are the same.

2. Isn't this just "hands-on"/experiential/inquiry learning?

No. Is practicing thinking like scientist with feedback.

Hands-on may involve those same cognitive processes, but often does not.

Reducing demands on working memory in class

- Targeted pre-class reading with short online quiz
- Eliminate non-essential jargon and information
- Explicitly connect
- Make lecture organization explicit.

clickers*--

Not automatically helpful--

give accountability, anonymity, fast response

Used/perceived as expensive attendance and testing device ⇒ little benefit, student resentment.

Used/perceived to enhance engagement, communication, and learning ⇒ transformative

- challenging questions-- concepts
- student-student discussion (“peer instruction”) & responses (learning and feedback)
- follow up instructor discussion- timely specific feedback
- minimal but nonzero grade impact

*An instructor's guide to the effective use of personal response systems ("clickers") in teaching-- www.cwsei.ubc.ca

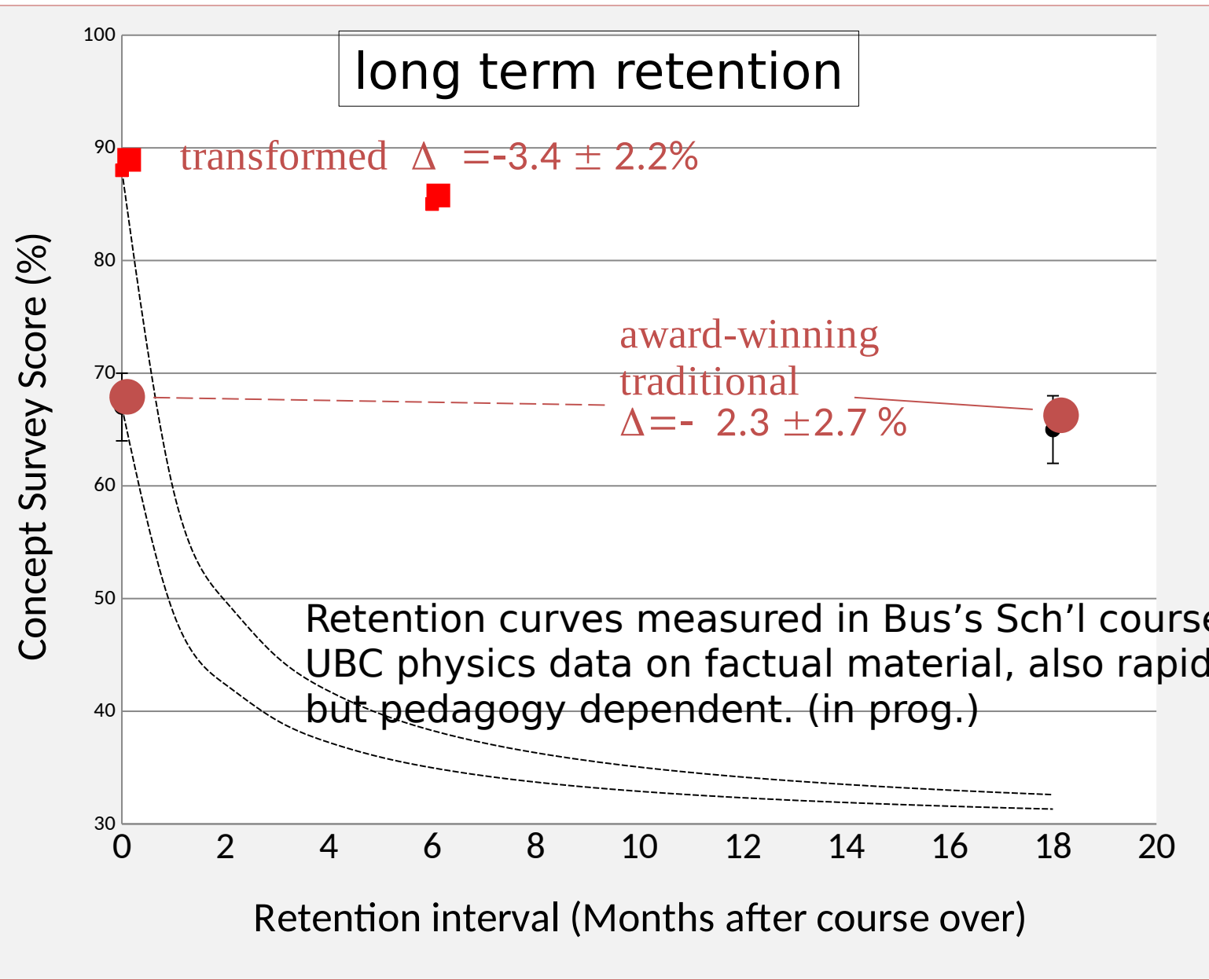

long term retention

transformed $\Delta = -3.4 \pm 2.2\%$

award-winning traditional
 $\Delta = -2.3 \pm 2.7\%$

Retention curves measured in Bus's Sch'l course.
UBC physics data on factual material, also rapid drop
but pedagogy dependent. (in prog.)

Design principles for classroom instruction

1. Move simple information transfer out of class.
Save class time for active thinking and feedback.

2. “Cognitive task analysis” -- how does expert think about problems?

3. Class time filled with problems and questions that call for explicit expert thinking, address novice difficulties, challenging but doable, and are motivating.

4. Frequent specific feedback to guide thinking.



DP

What is the goal of education?

Students learn to make better decisions.

Appropriate knowledge and processes of science to make better decisions with limited information.

Never more important than today

At course and program level:

In relevant contexts, use the knowledge and reasoning of the discipline to make good decisions (“expertise”).

Rest of talk– research on how to teach most effectively (“practice!”)